

# WHERE NEXT



**QUINTREX**

## CHECK YOUR OPTIONS

A GUIDE TO CHOOSING THE BEST ELECTRONICS FOR YOUR NEW QUINTREX BOAT.

All Quintrex boats are standard with all-new Active Imaging™ HD 3-in-1 Transducer - just select your desired display unit below.

### ActiveImaging<sup>HD</sup> TRANSDUCER

Step up to the ultimate fish finding clarity with new, high-definition Active Imaging™ HD sonar up to 1.2MHz. The Active Imaging HD transducer not only delivers three key sonar technologies – Lowrance® CHIRP, SideScan and DownScan Imaging™ – in one convenient package, but also features a new transducer design that boosts signal clarity.

### ELITE<sup>FS</sup>

ELITE FS supports the complete line-up of Lowrance® sonar and integrations in an easy to use and easy to install package. Elite FS is available in 9- and 7-inch models, comes preloaded with new, high detail C-MAP Discover OnBoard charts and now supports the new, high-resolution ActiveTarget 2 Live Sonar and Active Imaging HD 3-in-1 with a S3100 Sonar Module.

### HDS<sup>PRO</sup>

HDS® PRO sets the standard for underwater visibility. Get the highest resolution live sonar with ActiveTarget® 2. And ultra high definition clarity with new Active Imaging™ HD. Bow-to-stern boat control with the Ultimate Fishing System™, and detailed C-MAP® charting make HDS PRO the most powerful fishfinding tool available.

HDS PRO available in sizes 9", 10", 12" and 16".



# LOWRANCE®

# CONTENTS

BUNDLE UP YOUR BOAT STYLE . . . . .	5	BOWRIDERS . . . . .	31
HULLS MADE FOR AUSSIE WATERS. . . . .	6	FREESTYLERS . . . . .	32
WE'VE GOT TRUE BLUE HISTORY. . . . .	8	CABINS . . . . .	34
QUINTREX WHY GO ANYWHERE ELSE? . . . . .	9	PLATE BOATS . . . . .	36
TINNIES . . . . .	11	TRIDENT FEATURES . . . . .	38
OPEN BOATS . . . . .	12	STRIPES & COLOURS . . . . .	42
EXPLORERS. . . . .	14	WRAPS . . . . .	43
HORNETS. . . . .	19	EXTRAS. . . . .	44
RENEGADES . . . . .	21	CANOPIES, BIMINIS & COVERS . . . . .	45
TOP ENDERS . . . . .	22	QUINTREX PARTS & ACCESSORIES . . . . .	46
FRONTIERS . . . . .	26	TRAILERS . . . . .	48
RUNABOUTS . . . . .	29		

HOOK<sup>Reveal</sup>™



Elite<sup>FS</sup>



HDS<sup>PRO</sup>



	SolarMAX™ HD Display	CHIRP	DownScan Imaging™	SideScan	FishReveal DownScan	FishReveal SideScan**	Genesis Live	Internal GPS Antenna (excludes sonar only displays)	Multi-Touch/Touchscreen	ActiveTarget™	ActiveTarget 2	ActiveTarget 2 Dual System Views	Active Imaging™ 3-in-1	Active Imaging HD (via additional S3100 module)	Automatic Routing	GHOST™ Trolling Motor Integration	Smartphone Integration & Controls	Ethernet Networking	Wireless Connectivity	NMEA 2000®	Engine Integration	SmartSteer™ Motor Integration	SmartSteer™ Motorguide™ X15 Trolling Motor Integration	Power-Pole® Anchors	Radar	Chart Overlays For ActiveTarget 2 and GHOST 360	NMEA 2000 Audio	High-Performance Processor	LiveCast™	Dual Channel CHIRP	NMEA 0183*	Video Input
HOOK <sup>Reveal</sup> ™	•	•	•	•	•	•	•	•	•	•	•	•	•	•	•	•	•	•	•	•	•	•	•	•	•	•	•	•	•	•	•	•
Elite <sup>FS</sup>	•	•	•	•	•	•	•	•	•	•	•	•	•	•	•	•	•	•	•	•	•	•	•	•	•	•	•	•	•	•	•	•
HDS <sup>PRO</sup>	•	•	•	•	•	•	•	•	•	•	•	•	•	•	•	•	•	•	•	•	•	•	•	•	•	•	•	•	•	•	•	•

\*\*Compatible only with HDS-12 and HDS-16 Live \*\*\*FishReveal SideScan requires a S3100 Sonar Module and ActiveImaging HD FishReveal transducer



# BUNDLE UP YOUR BOAT STYLE

We're all about less hassle and more fun. That's why we've made things simple with a range of boat bundles to suit your lifestyle, or should we say boat-style!

Keen to get straight out on the water with a you-beaut ride? Our entry models will suit you just fine, decked out with all the essentials to get you going.

Level up your Quintrex boat with one of our Fishing, Comfort or Captain's Bundles. Can't decide? Roll all three into one for the ultimate boating experience with our Pro option. It's what we call having the best of the best.

We make building your ideal boat easy. So, what are you waiting for? Check out our lineup to find your perfect boating match now.



## FISHING BUNDLE



All the extras to play hard or fish hard, bundled up and ready to hit the water.

## COMFORT BUNDLE



Love your creature comforts? Check out our pre-packaged editions in each range, for just chillin' on a lazy Sunday.

## CAPTAIN'S BUNDLE



Be the master of all you survey. Our Captain's Bundle comes complete with steering and control upgrades.

## PRO



The ultimate boating experience on selected models includes the Fishing, Comfort and Captain's Bundles all wrapped up so you can have the best of the best.

# HULLS MADE FOR AUSSIE WATERS

The Apex Hull is the most modern and ground-breaking design to hit the water. Through years of research and development it's the new benchmark for aluminium boating, revolutionising the pinnacle of on-water performance with an all-round smoother, stronger and more superior ride.

It's built to take choppy conditions head-on, scientifically formed with 4mm to 5mm bottom sheets and 3mm side sheets of the highest quality marine grade aluminium. The sculpted flare slices through water and runs strategically aft to maintain contact with the water while on the plane. Its wide chine opens the front of the hull, carrying the flare further up the stem line for an impressively smooth ride. Plus the wide chine gives great stability and grip when cornering with increased bow surface area for optimal lift and level attitude.

Enjoy more space with fully welded Raised Side Decks on select Apex models, which jumps up the internal volume by 20% along with the freeboard by 80mm.

We've upped the overall footprint of the Apex Hull by 5% with its forked bow design allowing for more functionality in the nose of the boat. The design allows for an expansive bow seating area in the Freestyler models and an impressive casting platform across the Frontier and Hornet ranges.

Up sized from every angle, the Apex Hull is an eyecatcher on the water, that dials up the boating experience with more comfort, safety and fishability.

Experience the APEX of boating with Quintrex.

Mastered with revolutionary stretch-forming techniques, Quintrex boats leave the marine industry in their wake with the best on-water experience in the market.

With a hull perfectly crafted to suit every waterway, Quintrex delivers the softest, driest, and safest ride for every boatie.



## FIGHTER SERIES BOW

The perfect fishing hull. Designed with a forked bow, the Fighter Series Hull increases the front deck and casting platform by 11%. With its impressive stability at rest, large storage capacity and easy installation of electric motors, the Fighter Series Bow makes fishing easy, exceeding all your angling needs. Traverse through estuaries, creeks and lakes for an inland fishing experience like no other.



## BLADE HULL

The versatile Blade Hull is one of the most sought-after hulls in the market. Quintrex has made waves in the industry with the innovative practices of stretch-forming aluminium, creating a vessel perfect for a wide range of conditions. The Blade Hull cuts through rough water with ease because of its sharp, sleek shape and increased deadrise.

Centered around a fine-tuned balance of convex and concave shapes, the Blade Hull delivers a lower planing speed and improved top-end speeds, increasing the overall energy efficiency of any boat.



## FLARED BOW

Our iconic Flared Bow design signifies a moment in history that changed the world of aluminium boating forever. First performed by founder, Terry Quantrell, the flared bow highlights a pivot-point which enabled the brand to deliver an incomparable ride performance. Through its concave shape, achieved only by stretch-forming aluminium, the Flared Bow deflects water spray away from the boat for a dry and comfortable ride.

# WE'VE GOT TRUE BLUE HISTORY

For 75 incredible years, Quintrex has been nurtured around a passion for boating with its foundations grounded in an ambition to deliver an on-water experience like no other. From its conception in 1945 to today, the brand has continued to reinvent boating by delivering hull designs that achieve an unrivalled ride performance thanks to innovative technologies created by its forefathers, Terry Quantrill and Arthur Arnold.

Pioneering stretch forming techniques, Quintrex expertly molds each hull by hand, which has earned the brand a reputation for an unmatched smooth, dry ride. Together with the strength, durability, and longevity of aluminium, Quintrex hulls cut through water with ease because of their concave and convex designs that were once only possible with fiberglass.

In finessing the skill of stretch forming, Quintrex utilises a purpose-built hydraulic system which elongates each

flat aluminium sheet over a precise forming dye. When changing the shape of the aluminium, the metal goes through a process called "Work Hardening". When performed correctly, the overall strength of the material is increased by altering the crystal structure of the aluminium, therefore making Quintrex boats safer and more reliable.

The combination of ingenuity and the investment in stretch forming practices has enabled the fruition of the industry renowned Blade Hull, Flared Bow and flagship Apex Hull. Whilst versatile in delivering a perfect boat for every waterway, each hull variation is designed with a flawless balance – a sharp entry to deliver comfortable handling while underway and a strong structure to achieve stability while at rest.

Over 350 skilled professionals are at the heart of Quintrex. With an eye for detail and four quality control

points throughout the Gold Coast factory, each boat is hand built from scratch with quality at the crux of creation. Crafted by the best in the trade from design conception to welding, paint, and finish, you can be assured that your boat will last for generations to come.

Perfected over decades, Quintrex delivers industry leading designs catered to every lifestyle. Now partnered with BRP, a global leader in powersports who owns a large portfolio of world renowned, industry-leading brands including Ski-Doo, Lynx, Can-Am and much more, Quintrex has a bright future filled with utmost quality and innovation ahead. After 75 years of success, the adventure has only just begun.

Jump aboard our journey and discover more exciting adventures for decades to come with Quintrex.

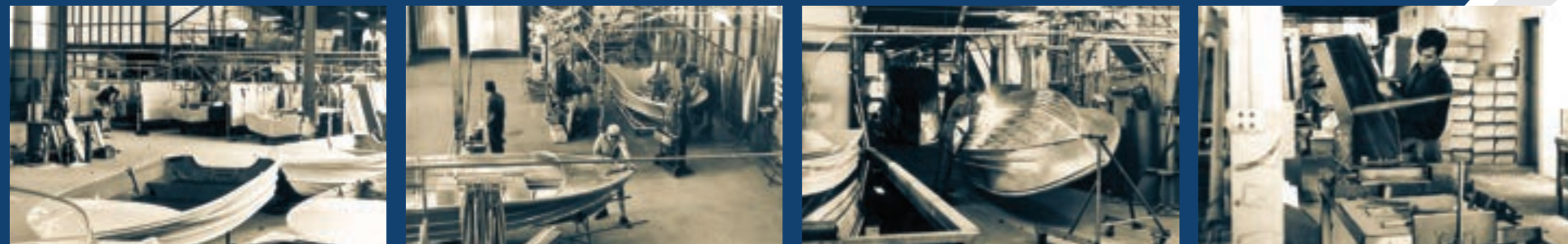

# QUINTREX WHY GO ANYWHERE ELSE?

## 5 YEAR WARRANTY

Backing its strong reputation of quality and passion towards crafting boats that last for generations, Quintrex will commit 5-years factory backed warranty on all new purchases. Simply follow the dealer maintenance schedule outlined in the Owner's Manual to qualify for the full 5-year term.\*

## DEALER NETWORK

As a proud leader in aluminium boat manufacturing that is recognised as the most successful business partner in the industry, Quintrex boasts the best dealer network in Australia. Armed with over 60 dealerships, scattered right across the country, Quintrex guarantees a wealth of boating expertise right at your fingertips plus ongoing support Australia-wide. With a passionate, experienced and welcoming team of dealers, Quintrex is your one-stop shop for boats, servicing, advice and boating accessories.

\*Terms and conditions apply.  
Consult your Quintrex Owner's Manual.

## BEST RESALE VALUE IN THE MARKET

As a testament to the superior name and product, Quintrex is renowned for having the best resale value in the market. Crafted with quality front of mind, Quintrex boats maintain a superior boating experience and rideability for generations. So, if you are looking to upgrade your Quinnie, you can rest assured that you will get a pretty penny for your second-hand boat.

Hand built in Australia, with the  
best resale value in the market.

If you ever want to let it go!

## A BOAT TO SUIT EVERYONE

With an exciting lineup of over 100 models, Quintrex arguably has one of the most versatile and diverse boat collections in the industry. Thanks to a passionate team of Research and Development professionals, each boat is perfectly crafted to meet customer demand, uphold the highest quality and safety standards plus deliver an unparalleled boating experience. From small tinnies, to a family runabout or bowrider, premier inland fishing vessels and offshore plate boats, Quintrex has you covered.



True to the name, Quintrex's mighty Wanderers and Cartoppers are built for the great nomads and adventurers. Decked out with wide ribs for stability and impressive functional space, it's a fishing must-have that's perfect for zipping around lakes and estuaries. Lightweight, economical and durable, throw your Quinnie Cartopper on your vehicle, camper trailer or caravan and let the adventure begin.

**DART** The perfect tinnie to dart around your local waterways or throw atop your vehicle for a fishing adventure. Light, affordable, and easy to handle, yet durable with strong sides and bottoms, the Dart is a fishing favourite for both avid and new boaties. **Available in 310, 370 and newly the 400; previously known as the Trigger.**

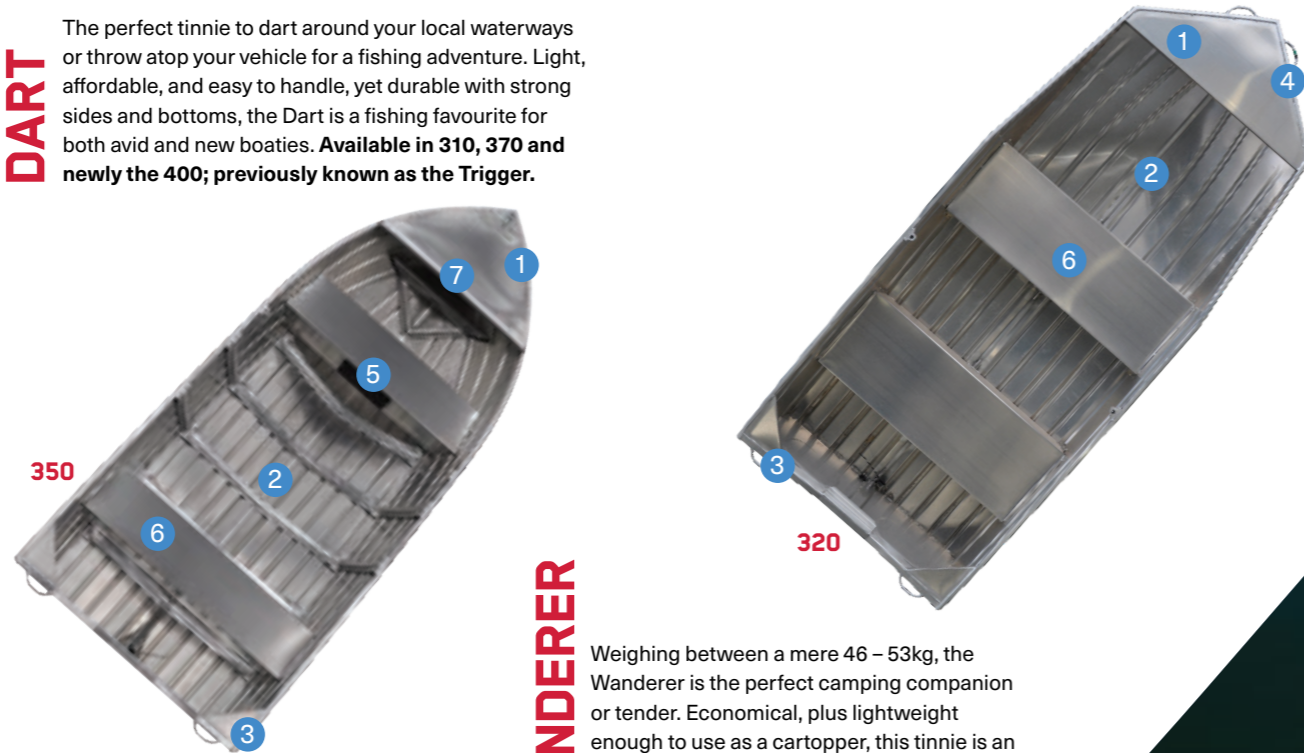

**WANDERER** Weighing between a mere 46 – 53kg, the Wanderer is the perfect camping companion or tender. Economical, plus lightweight enough to use as a cartopper, this tinnie is an attractive asset that boasts versatility whilst being budget friendly. **Available in 300, 320 and 360.**



# TINNIES

CHECK OUT THE RANGE DETAILS or go to [quintrex.com.au](http://quintrex.com.au)

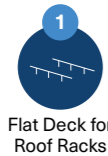

Flat Deck for Roof Racks



Wide Beam for Stability



Solid Corners & Transom Handles



Bow Handle



Glove Box



Wide Bench Seats

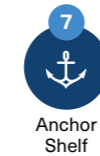

Anchor Shelf

# OPEN BOATS



Whether you're a first-time boatie or simply looking for another reason to get out on the water – the quintessential tinnie may be just for you. Dive into the diverse range of Quintrex tinnies to find your perfect companion for camping, fishing, surfing trips and more. Affordable, durable, versatile and built to last, Quintrex has all your tinnie needs covered.

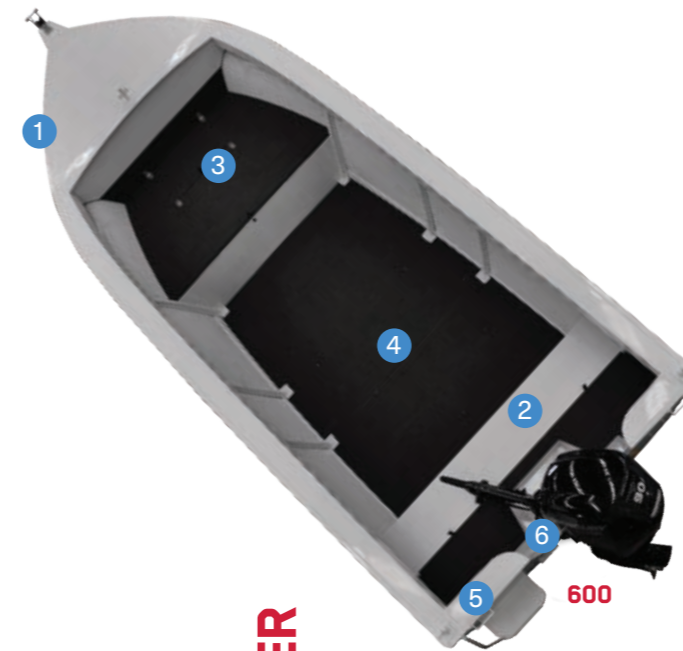

## FISHSEEKER

The Fishseeker encompasses the perfect combination of size and use. At 6m it is the biggest tinnie in the Quintrex range and in turn, the most spacious. Vast open fishing space, plus its Blade Hull and Flared Bow combination make it the ultimate fishing vessel. **Available in 600.**

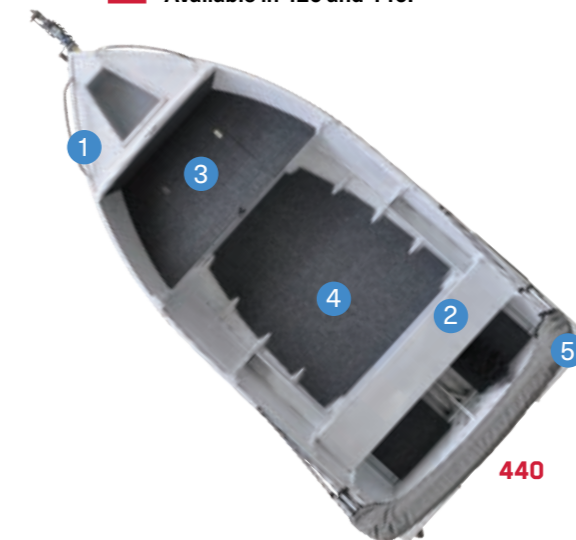

## BUSTA

Crafted with a deep freeboard, expansive open interior space, a large casting deck and the innovative Blade Hull, the Busta range delivers an impressively smooth ride and unparalleled fishing experience. Overall, it is the perfect entry-level tinnie for traversing rivers, lakes and estuaries. **Available in 420 and 440.**



-   
 1  
 Blade Hull
-   
 2  
 Wide Bench Seats
-   
 3  
 Casting Platform with Storage
-   
 4  
 Wide Beam for Stability
-   
 5  
 Transom Step and Rail
-   
 6  
 Splashwell

**CHECK OUT THE RANGE DETAILS**  
or go to [quintrex.com.au](http://quintrex.com.au)



# EXPLORERS

Experience all that Australia has to offer with the ultimate travel companion – Quintrex’s mighty Explorer. Crafted to go the distance from your backyard to the next – even up to the NT – the Explorer range is built for life on the road. Lightweight and available in a range of sizes, this tinnie is economical and versatile, making for the ideal tender, inland fishing vessel or cartopper.

So, where next?



## EXPLORER

Aptly named, the Explorer is built for pioneering. Designed with only the essentials to simply get you out on the water, it is affordable, stable and easy to manoeuvre. Lightweight, they also serve as the perfect cartopper. **Available in 350, 370 and an all-new 390.**



350



390

## FIGHTER SERIES EXPLORER

Designed with the Fighter Series Bow, this tinnie is built for fishing, delivering a front deck and casting platform that is 11% larger than traditional builds. With its impressive stability at rest, large storage capacity and easy installation of electric motors, the Fighter Series Explorer exceeds all your angling needs. **Available in 390 and 420.**



CHECK OUT THE RANGE DETAILS  
or go to [quintrex.com.au](http://quintrex.com.au)



Fighter Series Bow



Wide Beam for Stability



Solid Corners & Transom Handles



Bow Handle



Glove Box

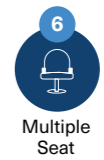

Multiple Seat Positions

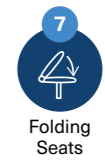

Folding Seats

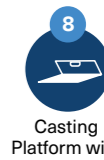

Casting Platform with Storage



## OUTBACK EXPLORER

Featuring 100mm higher topsides and a greater deadrise than any other Explorer model, the Outback Explorer guarantees a smooth and dry ride. Take boating to the next level with your robust, spacious tinnie, available with an array of options. Available in 350, 370 and 390.

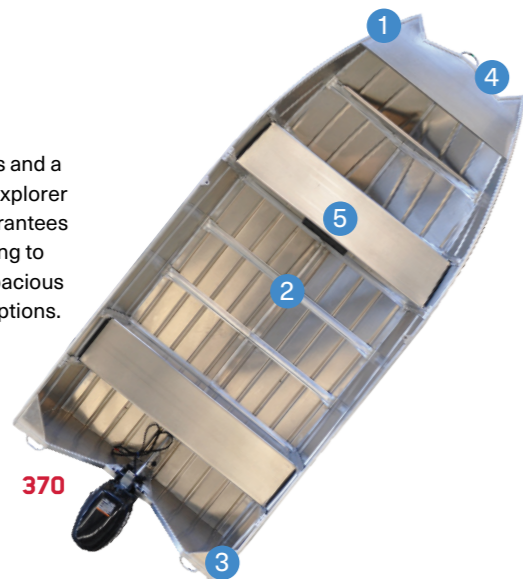

370

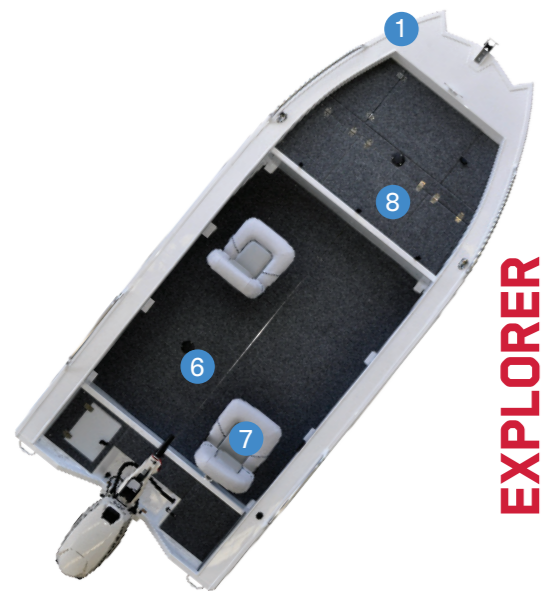

F420

## EXPLORER PRO

The newest addition to the Quintrex lineup. Designed around the ever-popular Explorer shape but featuring deeper side sheets, the Explorer Pro is built for more waterway diversity than ever before. Whether traversing estuaries, creeks or lakes across Australia, the Explorer Pro is set to be your trusty sidekick. Available in 350 and 370.



350

CHECK OUT THE RANGE DETAILS

or go to [quintrex.com.au](http://quintrex.com.au)



## EXPLORER TROPHY

The Explorer Trophy has become one of Australia's most loved tinnies. Its 2mm topsides and up to 3mm bottomsides deliver a strong, reliable vessel whilst the Fighter Series Hull delivers impeccable stability. Standard with rod holders, and a front and rear casting platform it is a boating no-brainer. Available in F400, F420 and F440.



Fighter Series Bow



Wide Beam for Stability



Solid Corners & Transom Handles



Bow Handle



Glove Box



Multiple Seat Positions



Folding Seats



Casting Platform with Storage



# EXPLORERS



The iconic fishing boat featuring all your fishing fundamentals. Now boasting the innovative Apex Hull, the Hornet is set to deliver a ride experience like never before with unrivalled stability underway and at rest in all conditions.

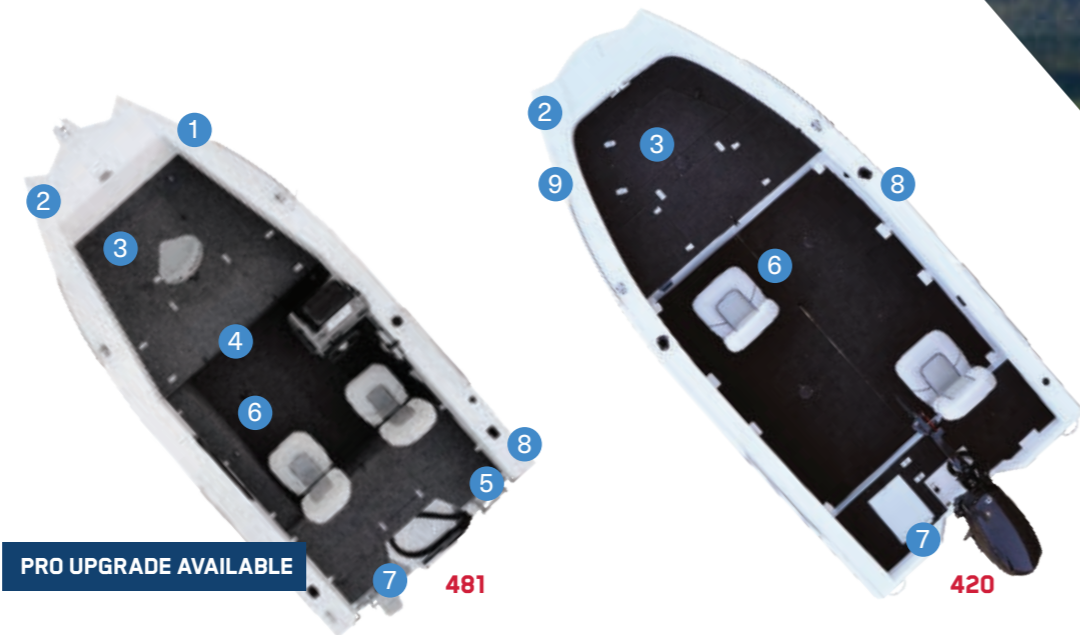









**HORNET** Designed for fishos, by fishos to deliver the ultimate fishing vessel. A perfect combination of the universal raised front and casting deck, revolutionary Apex Hull, and ample storage space make it any boaties dream. Available in 450, 481 and 510.

**HORNET TROPHY** The perfect fishing vessel with an open deck area and large front casting platform. With its compact size and horsepower rating of up to 60HP, zip around your favourite waterways with ease. Experience the Fighter Series V-Flared hull for unmatched stability. Available in 420 and 440.

# HORNETS



-   
 1  
 Apex Hull
-   
 2  
 Fighter Series Bow
-   
 3  
 Casting Platform with Storage
-   
 4  
 Glove Box
-   
 5  
 Rear Ladder
-   
 6  
 Carpeted Floor for Stability
-   
 7  
 Livewell
-   
 8  
 Rod Holders
-   
 9  
 V-Flare Hull

**GET A COMPLETE BOAT BUNDLE**  
 see page 3 or go to [quintrex.com.au](http://quintrex.com.au)



## TILLER STEER

For unequalled control while trolling and a more traditional boating experience, tiller steer is the answer. Opt for tiller in a range of Renegade models and enjoy the unsurpassed design of Quintrex boats. Available in 420, 440 and 460.



PRO UPGRADE AVAILABLE

440

## SIDE CONSOLE

Boasting a wide range of sizes, there is a Renegade that suits everyone. Enjoy vast, open interior space along with the comfortability of a side console. Fitted standard with a rear casting platform and four rod holders, plus boasting a beamy, wide and stable build, the Renegade is made for fishing. Available in 420, 440, 460, 490, 530 and 570.



PRO UPGRADE AVAILABLE

570



## CENTRE CONSOLE

With 360-degree fishability, the Centre Console layout is built for avid fishos. Featuring the Blade Hull and front casting platform, the Renegade not only provides an impressively stable and open fishing space but also, ample storage room for gear. It also comes standard with a live bait tank. Available in 440, 460, 490, 530 and 570.



PRO UPGRADE AVAILABLE

530

The Renegade is making a splash as a standout favourite for all your angling needs with an unbeatable Blade Hull ride across any waterway. Decked out with a spacious front and rear casting platform that is remarkably stable at rest, the Renegade is a cost-effective option offering a priceless boating experience.

# RENEGADES



GET A COMPLETE BOAT BUNDLE

see page 3 or go to [quintrex.com.au](http://quintrex.com.au)



Blade Hull



Smooth Sides



Folding Seats



Casting Platform with Storage



Live Bait Tank



Carpeted Floor for Stability



Side Decks for Strength



Transom Step and Rail

# TOP ENDERS



Originally crafted for the Northern Territory, the Top Ender is the master-class fishing boat. Built for tropical conditions, remote creeks, estuaries and open bays, the barra-bass tournament style layout is designed with deep sides, a Blade Hull and Flared Bow.





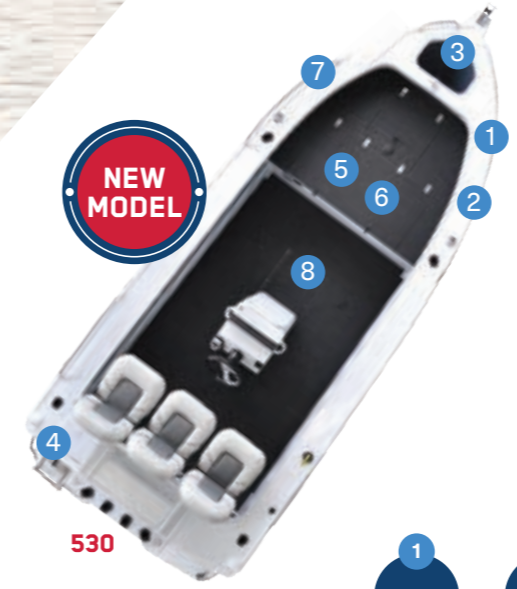



## TOP ENDER

The Top Ender delivers an unparalleled barra-bass tournament style boat. Crafted with a live bait tank as standard and a front casting platform with jaw-dropping storage capacity. Available in 430, 450, 481, 500, 520, 540 and 590.



## TERRITORY LEGEND

Crafted with a rear console to maximise fishable space and extruded side decks for added support when reeling in a catch, this is a legend of a boat. Featuring a front casting platform, live bait tank, transom ladder, hydraulic steering and much more as standard, the Territory Legend delivers the ultimate fishing experience. Available in 540, 590 and 610.

- 1  
  
 Blade Hull
- 2  
  
 Flared Bow
- 3  
  
 Anchorwell
- 4  
  
 Live Bait Tank
- 3  
  
 Casting Platform with Storage
- 6  
  
 110L Esky Storage Capacity
- 7  
  
 Bow Mount Plate
- 8  
  
 Premium Carpets



**GET A COMPLETE BOAT BUNDLE**  
see page 3 or go to [quintrex.com.au](http://quintrex.com.au)



**TOP ENDER**  
**XX**

Heralded as the ultimate crossover boat, the Top Ender XX delivers an unparalleled fishing and leisure experience all in one. Crafted around the legendary Top Ender design with the Blade Hull, but featuring a V-Bunk front lounge, the Top Ender XX provides the best hybrid product in the market.



Blade Hull



Flared Bow



Anchorwell



Live Bait Tank



Casting Platform with Storage



110L Esky Storage Capacity



Bow Mount Plate



Premium Carpets

**NEW MODEL**

XXX



# TOP ENDERS



**GET A COMPLETE BOAT BUNDLE**

see page 3 or go to [quintrex.com.au](http://quintrex.com.au)

# FRONTIERS



A reinvented fishing experience with the innovative Apex Hull. Available in multiple console configurations with a large casting platform and ample underfloor storage. It's a tough machine for serious fishos.

## SIDE CONSOLE

Quintrex's groundbreaking Apex Hull design gives fantastic stability and greater contact on-water with its wide, flared bottom sheets. Kitted up for all your fishing adventures with a live bait tank, rear ladder, marine radio and scuppers as standard. **Available in 510, 530, 550, 590 and 630.**

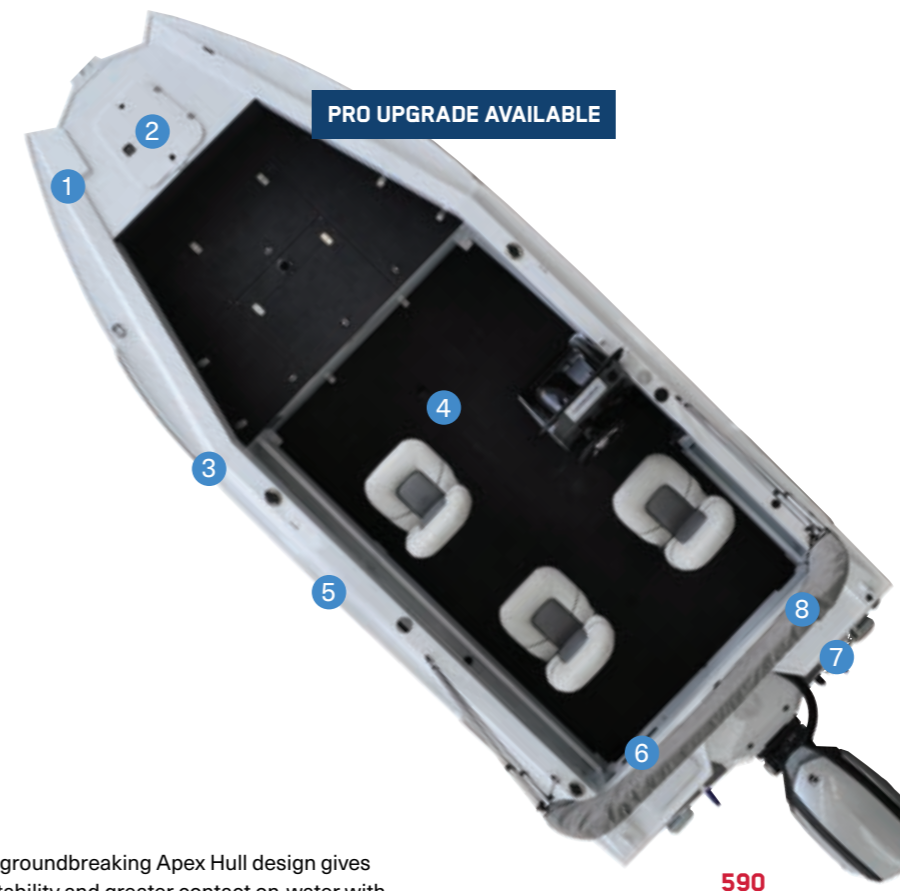

Apex Hull



Moulded Anchorwell



4mm Bottom Sheets



Premium Carpets



Raised Side Decks



Telescope Rear Ladder



Live Bait Tank With Viewing Window



Optional Bimini and Envelope



**GET A COMPLETE BOAT BUNDLE**

see page 3 or go to [quintrex.com.au](http://quintrex.com.au)





One of our most sought-after models, built for exploring endless dream destinations. Fishabouts are versatile and easy to handle with a large open deck space, generous person capacity and endless customisation opportunities. Perfect for fishing, watersports, diving and making lifetime memories.

**GET A COMPLETE BOAT BUNDLE**

see page 3 or go to [quintrex.com.au](http://quintrex.com.au)



430

**FISHABOUT**

Ranging from 5 – 7 person capacity and available with a wide range of options, the Fishabout is not only versatile, but is also built tough with the industry-leading Blade Hull design. Crafted around 3mm topsides and up to 5mm bottomsides, the Fishabout expertly handles choppy conditions. **Available in 430, 450, 481, 500, 520 and 540.**

-   
Blade Hull
-   
Flared Bow
-   
Rear Folding Lounge
-   
Transom Step and Rail
-   
Lean Through Dash
-   
Moulded Dash
-   
Anchorwell
-   
Rear Ladder

# RUNABOUTS





Leave your everyday in the wake as you cruise into relaxation, luxury and a lifetime of thrills aboard your Quintrex Cruiseabout. With plush bow cushions or rear folding lounges, throw a tube on the back for an adventure filled with laughter in smooth style thanks to the Blade Hull.

# BOWRIDERS

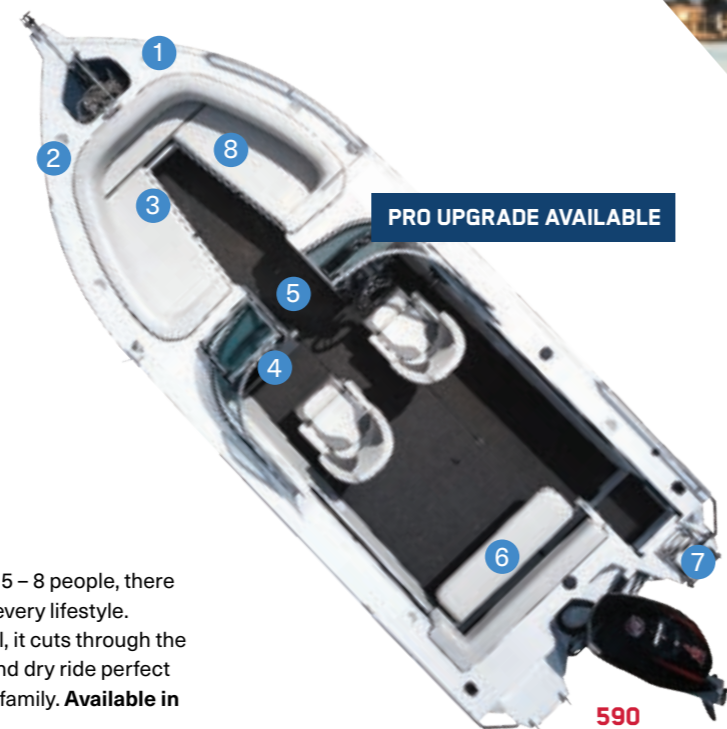

## CRUISEABOUT

With a person capacity from 5 – 8 people, there is a Cruiseabout perfect for every lifestyle. Designed with the Blade Hull, it cuts through the water, delivering a smooth and dry ride perfect for cruising with friends and family. **Available in 481, 500, 520, 540 and 590.**

 **GET A COMPLETE BOAT BUNDLE**  
see page 3 or go to [quintrex.com.au](http://quintrex.com.au)

-   
 1  
**BLADE HULL**  
 Blade Hull
-   
 2  
**FLARED BOW**  
 Flared Bow
-   
 3  
**BOW CUSHIONS WITH STORAGE**  
 Bow Cushions with Storage
-   
 4  
**GLOVE BOX WITH DRINK HOLDERS**  
 Glove Box with Drink Holders
-   
 5  
**WALK-THROUGH DASH**  
 Walk-Through Dash
-   
 6  
**REAR FOLDING LOUNGE**  
 Rear Folding Lounge
-   
 7  
**REAR LADDER**  
 Rear Ladder
-   
 8  
**CONVERTIBLE CASTING PLATFORM**  
 Convertible Casting Platform





# FREESTYLERS



590



PRO UPGRADE AVAILABLE



The Freestyler is based around the versatile bowrider layout with the groundbreaking Apex Hull design. There is no other boat more perfect for all your watersports, fishing, cruising and camping needs. Enjoy ample storage, a sporty design and impressively smooth ride.

## FREESTYLER

The Freestyler boasts an impressive person capacity of 6 – 7 people and comes standard with a sound system and speakers, underfloor storage, rear ladder, and scuppers. A forked bow design increases the overall bow seating area which means more room for you to kick back and relax. Available in 510, 530, 550, 590 and 630.



Apex Hull



Hidden Anchorwell



4mm Bottom Sheets



Deluxe Bow Cushions & Backrest



Raised Side Decks



Telescope Rear Ladder



Deluxe Folding Rear Lounge



GET A COMPLETE BOAT BUNDLE

see page 3 or go to [quintrex.com.au](http://quintrex.com.au)

# CABINS



A day is never long enough for boating, and this is the perfect boat for long trips. The versatile Ocean Spirit features ample cabin storage with luxurious cushions for comfortable overnight stays or a sun shelter for the kids on hot days. Build your perfect fishing, family, camping or watersports boat with the wide range of available options.



## OCEAN SPIRIT

Features a new cabin design and dash, now capable of housing larger electronics. Designed with the Blade Hull using marine grade 3mm topsides and 4mm bottomsides, the Ocean Spirit is built strong to take offshore conditions head-on. Build the boat that fits your budget with a range of options. Available in 520, 540 and 590.



**GET A COMPLETE BOAT BUNDLE**

see page 3 or go to [quintrex.com.au](http://quintrex.com.au)



Blade Hull



Flared Bow



Anchorwell



Walk Through Cabin Hatch



Cabin Cushion



Rear Folding Lounge



Rear Ladder



Underfloor Storage

# PLATE BOATS



Built to rule the ocean. Command the seas in the ultimate hardcore fishing boat, crafted from strength within and technologies that have been tested and tried for generations. Marine grade 5mm plate bottom sheets, used to stretch-form the state-of-the-art Blade Hull, deliver a strong vessel that cuts through unruly offshore conditions. It's a fishing force to be reckoned with.



## HARD TOP

Boating is on the forecast whether it's rain or shine with the Trident Hard Top. Keep dry as you take the rain head-on thanks to full weather protection, complete with a fully enclosed hardened windscreen, sliding side windows and a windscreen wiper kit. Available in 610, 650 and 690.



## SOFT TOP

Designed for hardcore fishos. The soft top delivers ample sun protection with a specially designed bimini that is foldable for storage, whilst the strong windshield and expansive cabin area offers extensive protection from the elements. Available in 610, 650 and 690.



CHECK OUT THE RANGE DETAILS  
or go to [quintrex.com.au](http://quintrex.com.au)



Blade Hull



Anchorwell



Live Bait Tank



Rear Ladder



Self Draining Treadplate Floor



Hydraulic Steering



Underfloor Fuel Tank



Rocket Launchers



Walk-Through Cabin Hatch

# TRIDENT FEATURES

## TRANSOM DOOR & REAR LADDER



Whether you are an avid spear fisherman, diver, or care for a dip whilst out on the water, the Trident has you covered. With a transom door and rear ladder standard across all models, entry and exit at the transom are not only easy but safe. Designed to meet the needs of all types of fishermen, the Trident is your perfect offshore Plate Boat.

## CUTTING BOARD



Factory-fitted with your fishing essentials, the Trident features a versatile bait station that sits neatly at the transom. Complete with a cutting board, rod holders, a knife sheath and tackle or cup holders, it makes reeling in your catch easy. For bulk tackle storage, stainless steel rod holders and a larger cutting board, option up to the Deluxe Bait Station.

## SCUPPER DRAINAGE SYSTEM

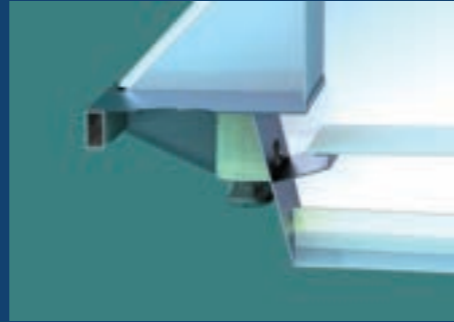

From keel to gunwale, your Trident has been built with care to deliver a safe and comfortable ride in all conditions. A carefully crafted self-draining treadplate floor with automatic, non-return scupper drainage comes standard in all Trident vessels to ensure the prevention of excessive water intake. Wide funnels, strategically placed at the transom, remove water from the hull, then filters it through flexible hosing which is designed to prevent water reentry.

## REEL EASY ROD HOLDERS



More than just your standard rocket launchers – the “Reel Easy Rod Holders” make stowing and accessing your fishing rods an effortless feat. The six rod holders are maneuverable with a simple quick-release pin system and come standard on all Trident Hard Top models.

## HARD TOP



Every day is a ripper with the Trident Hard Top, no matter the weather. Whilst the wrap-around shelter protects you from the elements, the laminated hardened glass windscreen, wiper kit and sliding side windows, ensure you have optimal visibility. The fish still bite, no matter the weather – will you be there to catch them?

## LIVE BAIT TANK



Have peace of mind that your baits will remain alive and well whilst stored in the live bait tank, standard with every Trident. Water continually circulates through the tank to oxygenate the water whilst underway due to an external pickup, while its glass window allows for easy viewing. Installed in the back deck, it neighbours the bait station for easy fishing prep.

We are extremely happy with the package. Awesome trailer to tow, release and retrieve due to the easy catch system. Boat is extremely comfortable and dry due to the hardtop and has plenty of all round visibility.

- Rod Lestrage

## THE TRIDENT HISTORY

Building on the powerhouse of Quintrex boats, Australia's leading aluminium boat brand launched its first ever brand-exclusive plate lineup in 2012 with the Trident cuddy-cabin range and has since boomed, quickly establishing itself as the king of the ocean.

In line with Quintrex's long-rooted reputation of being the industry-leader in marine since its inception in 1945, the Trident range is derived from years of research and development, delivering a groundbreaking offshore boat. Innovation and revolutionary technologies such as aluminium stretch-forming achieve a superior ride experience with the Blade Hull, a staple in the Trident range. Concave flared side sheets and bottom sheets deliver a sharper entry point, increased deadrise and a narrower shoulder that allows the hull to cut through choppy conditions with ease. The Trident is grounded in strength, with 5mm plate bottom sides and a strategic egg-crate construction with fully-welded 5mm longitudinal and latitudinal ribs.

The fish are on – take them head on with the industry leading Trident plate boat.





WE HAVE THE BOAT  
BUNDLES AND  
ACCESSORIES TO MAKE  
YOUR DAYS ON THE  
WATER UNFORGETTABLE

**MAKE  
IT YOUR  
CUSTOM  
GETAWAY**

# STRIPES & COLOURS

## HULL STRIPES



- Left Stripe
- Always Anthracite\*
- Right Stripe

\*White on painted hulls

## STRIPES COLOURS



All colours shown are as close as the reproduction process allows.

Donning an all-new look, the entire Quintrex range has been relaunched with a fresh stripe design.

The stunning pattern will become a recognisable cornerstone of the Quintrex brand on and off the water. Make the design your own with a two-toned hull and specialised striping of your chosen colours. All stripes are installed with high quality material and utmost care in the Australian factory.

## FULL COLOURED HULL



**BUILD YOUR PERFECT BOAT TODAY**

or go to [quintrex.com.au](http://quintrex.com.au)



## CLAW

Available in blue (as above), black, green and red.



## ICE

Available in aqua (as above), blue, black, green and red.



## CAMOUFLAGE

Available in snow (as above), military green, ocean blue, grey, desert brown and autumn orange.



## QUINTREX AUSTRALIA

Available in blue (as above), green, purple, red and yellow.

# WRAPS

Make a statement on the water with a custom wrap, set to add an extra edge to your boat. Not only are they striking but, optioning up with a vinyl wrap provides a hardy and protective way to personalise your boat.



## SWEEP

Available in blue (as above), aqua, green, red and purple.



## GEOMETRIX

Available in red (as above), yellow, grey, blue and green.



## ADRENALINE

Available in green (as above), blue purple, red and yellow.

# EXTRAS



Burley Bucket



Rod Locker (Hornets Only)



Casting Platform For Esky / Fridge



Transom Door



Wake Tower



Ski Pole Cutting Board



Live Bait Tank In Back Deck



Side Pocket



Ski Pole



Drum Winch



Bow Mount Plate



Sounder



Marine Radio



Deluxe Rear Lounge



Mechanical / Hydraulic Steering

Build the perfect boat for your lifestyle. With over 100 genuine options, Quintrex proudly offers one of the most customisable ranges available, making it also the most versatile. Create your dream boat with ease by decking your new ride out with options ideal for hardcore fishing, family fun, watersports, or all of the above.

For boating made easy, upgrade with Quintrex's new, specialised Boat Bundles to simply construct the vessel that suits your needs. Speak to your dealer about the Quintrex genuine options available with your boat, which are all factory fitted by a passionate team of industry-best professionals and backed by Quintrex warranty.

## ACCESSORY KIT

### THE QUINTREX ACCESSORY KIT INCLUDES:

- Auto Bilge
- Pump
- Battery Box
- Isolator
- Switch
- Navigation Lights
- Switch Panel

Please see separate features for plate boats.

## SEATS



Maritime Sports Seat



APEX Sports Seat



Fish Sports Seat



BASS Sports Seat



Angler Sports Seat



Tonneau/Bow Cover - Bowrider



Bimini - Top Ender



Bimini - Bowrider



Bimini NT / NQ — for extra height and cover



Bimini - Runabout



Front clears and Curtains Cuddy Cabins, Runabouts & Bowriders (side curtains available)

Available for most boats across the Quintrex range. Contact your dealer for more information.

# CANOPIES, BIMINIS & COVERS

The safety of your boat, from top to bottom, is our priority.

That's why you can upgrade a wide range of Quintrex boats with a bimini, side clears and front curtains to protect you from the elements. Keep your vessel in schmick shape during storage and towing with bow, storm and travel covers to shelter it from dust and weather.

All Quintrex genuine canopies, biminis and covers are guaranteed to be the perfect fit. Measured, cut and sewn in the Quintrex factory, each item is crafted specifically for your boat.



Red



Burgundy

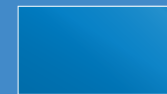

Pacific Blue



Persian Green

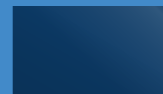

Captain Navy

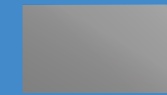

Cadet Grey

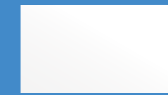

White on Grey

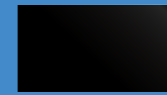

Jet Black

All colours shown are as close as the reproduction process allows. To view all colours visit [quintrex.com.au](http://quintrex.com.au)

# QUINTREX PARTS & ACCESSORIES



Fish Bag



Esky



Phone Charger



Rod Storage



Trailer Stone Guard

As boaters, we know that boaters can't take to the water without the essentials. With quintrex's all-new, exclusive parts and accessories range, gearing up for that perfect day out has never been easier. From eskys to covers and coolers, a wide range of accessories and optional extras are now available to

purchase as stand-alone items or with any new quintrex boat. Only available from your local quinnie dealer.



**BUILD YOUR PERFECT BOAT TODAY**

or go to [quintrex.com.au](http://quintrex.com.au)

## QUINTREX PARTS & ACCESSORIES

- Fish Bag
- Esky
- Rod Storage
- Trailer Stone Guard
- Surface Protection
- Underwater Lights
- Seat Covers
- Phone Charger
- Sound System
- Boat Cover
- Cooler



# TRAILERS



Our trailers are specially calibrated to each boat, guaranteed to deliver the safest wheels for your ride. Made with marine grade aluminium and structurally tested to withstand the torture track, Quintrex trailers maintain safe operation and integrity over 100,000km on Australia's grueling roads.

Aluminium makes our trailers strong, durable and resistant to rust whilst being light and flexible. As opposed to box section frames, Quintrex uses C channels for the main trailer structure to prevent the retention of water.

You can also purchase a stand-alone trailer through Quintrex's loose trailer program, meaning everyone can experience the Quintrex difference.

Either upgrading an old trailer or matchmaking your new boat we have you covered with reliable wheels backed by factory warranty.



**CHECK OUT THE RANGE DETAIL**  
or go to [quintrex.com.au](http://quintrex.com.au)

## ONLY A QUINTREX TRAILER HAS BEEN CUSTOM DESIGNED TO MATCH YOUR BOAT

TRAILER CODE	DESCRIPTION	BOAT FITMENT GUIDE M	ATM KG	LENGTH MM	TARE WEIGHT KG	WIDTH MM	BRAKES	RIM SIZE	ALLOY / STEEL WHEELS	GALVANISED AXLE / SPRING	SEALED BEARING UNITS	LED LIGHTS	WALKWAY	SPARE WHEEL & CARRIER	CATCH & RELEASE
ALUMINIUM LIGHT SERIES															
TALS749S13S	Alloy light short - skid	3.5 - 3.99	749	4630	140	1820	NO	13"	S	Y	Y	Y	Opt	Opt	N
TALL749S13S	Alloy light long - skid	3.9 - 4.4	749	5120	160	2140	NO	13"	S	Y	Y	Y	Opt	Opt	N
TALL900S13B	Alloy light long - skid	3.9 - 4.4	900	4870	220	2160	YES	13"	S	Y	Y	Y	Opt	Opt	N
ALUMINIUM SERIES															
TA749S13S	Alloy I-Beam - Skid	4.1 - 4.6	749	5360	220	2250	NO	13"	A	Y	Y	Y	Opt	Opt	Opt
TA1098S13SB	Alloy I-Beam - Skid	4.1 - 4.7	1098	5360	280	2250	YES	13"	A	Y	Y	Y	Opt	Opt	Opt
TA1100S13SB	Alloy I-Beam - Skid	4.5 - 4.9	1100	5700	293	2250	YES	13"	A	Y	Y	Y	Opt	Opt	Opt
TA1298S13SB	Alloy I-Beam - Skid	4.8 - 5.2	1298	6070	297	2250	YES	13"	A	Y	Y	Y	Opt	Opt	Opt
TA1400S13SB	Alloy I-Beam - Skid	4.8 - 5.2	1400	6070	280	2250	YES	13"	A	Y	Y	Y	Opt	Opt	Opt
TA1595S14SB	Alloy I-Beam - Skid	5.1 - 5.4	1595	6400	320	2250	YES	14"	A	Y	Y	Y	Opt	Opt	Opt
TA1850T13SB	Alloy I-Beam - Tandem Skid	5.6 - 5.8	1850	6700	400	2250	YES	13"	A	Y	Y	Y	Opt	Opt	Opt
TA1999T13SB	Alloy I-Beam - Tandem Skid	5.8 - 5.9	1999	6810	480	2250	YES	13"	A	Y	Y	Y	Opt	Opt	Opt
TA2000T13SB	Alloy I-Beam - Tandem Skid	5.8 - 6.1	2000	6970	440	2250	YES	13"	A	Y	Y	Y	Opt	Opt	Opt
MULTI-ROLLER SERIES															
TAB612000T13RB	Alloy I-Beam - Blade Tandem Multi-Roller	5.9 - 6.1	2000	6970	440	2250	YES	13"	A	Y	Y	Y	Opt	Opt	Opt
TAB652000T13RB	Alloy I-Beam - Blade Tandem Multi-Roller 6	6.3 - 6.5	2000	7100	440	2250	YES	13"	A	Y	Y	Y	Opt	Opt	Opt
TAB692600T14RB	Alloy I-Beam - Blade Tandem Multi-Roller	6.4 - 6.6	2000	7640	560	2250	YES	14"	A	Y	Y	Y	Opt	Opt	Opt
TAB692750T14RB	Alloy I-Beam - Blade Tandem Multi-Roller	6.8 - 7.1	2750	7640	560	2250	YES	14"	A	Y	Y	Y	Opt	Opt	Opt

\*Please check with your local dealer for state availability on certain models

\*2600 and 2750 Quintrex trailer comes standard with Hydrostar hydraulic brake system

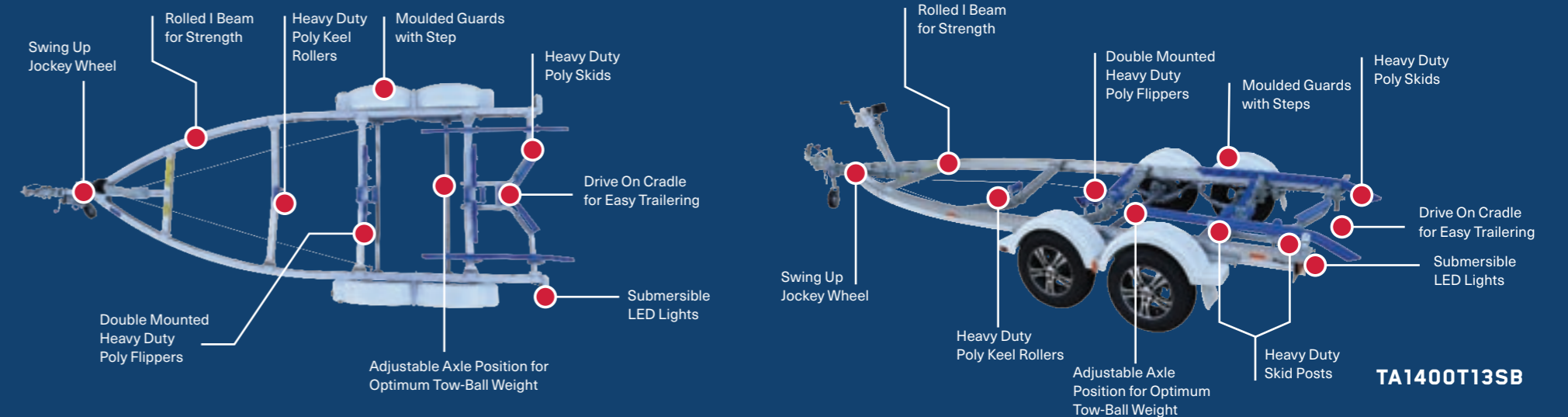

TA1400T13SB

## OPTIONS



Catch n Release



Hydro Braking System



Spare Wheel



New Rim



Trailer Walkway



Swing Away Draw Bar



Gal Spare Wheel Carrier



# WHERE NEXT

**WE HAVE THE PERFECT BOAT PACKAGE FOR YOUR NEXT ADVENTURE.**

## STANDARD

Our standard boat configurations, loaded with all the important things.

## BUNDLED

Choose from our optioned-up bundles for the style of boating you enjoy.

## PRO

Our deluxe boating experience, with the best of everything.

The contents of this brochure, excluding Warranty Provisions, will not form part of any contractual agreement. Quintrex recommends all persons comply with their local boating regulations and are familiar with safe boating practices. This brochure is designed to provide you with an introduction to the Quintrex Products (including available optional equipment). Because of changes in conditions and circumstances Quintrex\* reserves the right at any time, at its discretion, and without notice, to discontinue or change the features, designs, materials, colours and other specifications and the prices of its products and to either permanently or temporarily withdraw any such products from the market without incurring any liability to any prospective purchaser. Details referred to in this brochure are based on pre-production specifications and could be altered or deleted prior to the boats sale date. Because of variations which occur in manufactured products, all capacities, measurements, dimensions and weights quoted should be taken as approximate only and are subject to change. Quintrex reserves the right to discontinue or change any of the exterior colours and interior trims referred to in this brochure at any time without notice. Every effort has been made to depict boat colours and trims as realistically as possible in this brochure; however some variation may occur due to printing limitations. Always consult an authorised Quintrex dealer to view actual colours and trims and for the latest information with respect to features, specifications, prices, optional equipment and availability before deciding to purchase. Quintrex does not offer factory direct sales or prices. For updated specifications, please refer to the Quintrex website [www.quintrex.com.au](http://www.quintrex.com.au)  
\*Quintrex- Telwater Pty Ltd. (A.B.N. 15 010 795 507) Printed January 2023. Design by Sin Design and Branding \*23749

# AUSSIE THROUGH & THROUGH



**QUINTREX**

FOLLOW US

 [QUINTREXAUSTRALIA](#)

 [QUINTREX.COM.AU](#)

 [@QUINTREXBOATING](#)

 [QUINTREXBOATING](#)